

# LÍNEA ELISEUM





**Definen a esta línea la elegancia y la distinción.**  
Pensada para áreas gerenciales y salas de conferencia.





Se destaca por sus espesores y terminaciones además **resuelve de manera inteligente temas de conectividad.**





# Gerencial

Fabricamos mobiliarios que te ayudan a tomar mejores decisiones.

ESCRITORIO ELISEUM  
3 CAJONES

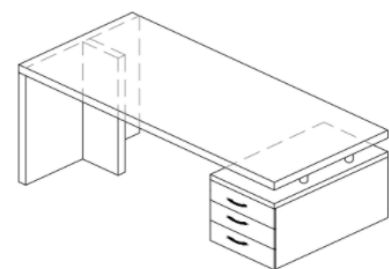

200 X 90  
180 X 80

ESCRITORIO ELISEUM  
CON DISCO

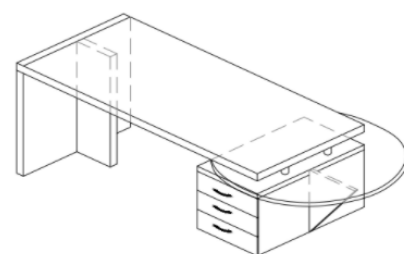

200 X 90  
180 X 80

DISCO EN MELAMINA  
LUSTRADO / EN ACERO

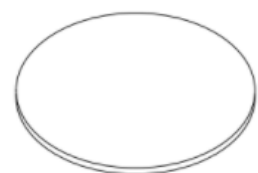

RADIO 100

EXTENSIÓN ELISEUM

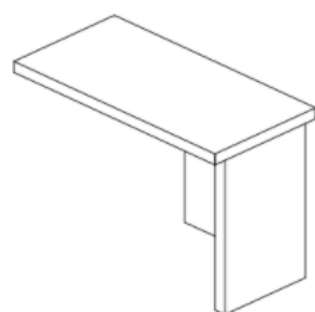

100 X 50







**G**erencial



# C onferencia

Diseñemos juntos el mobiliario que te genere mejor energía.

## MESA DE REUNIÓN

### RECTANGULAR

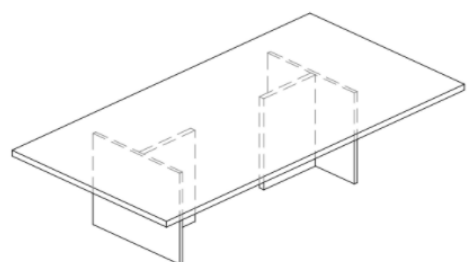

180 x 90  
210 X 100  
260 X 120  
300 X 140  
350 X 140

### BOTE

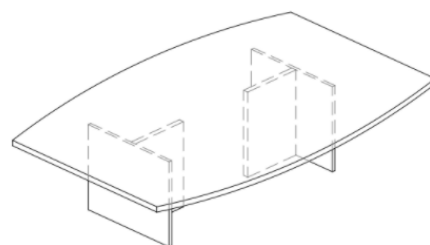

180 x 90  
210 X 100  
260 X 120  
300 X 140  
350 X 140

### OVAL

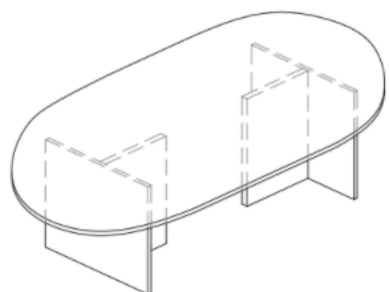

180 x 90  
210 X 100  
260 X 120  
300 X 140  
350 X 140

### REDONDA BASE CRUZ

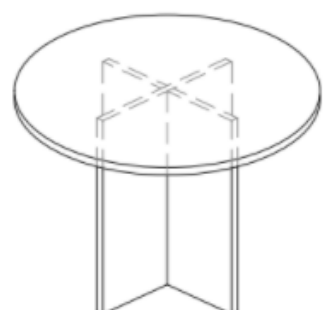

100  
120  
140  
150  
170









## ESCRITORIOS

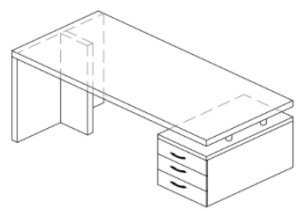

ESCRITORIO ELISEUM 3 CAJONES

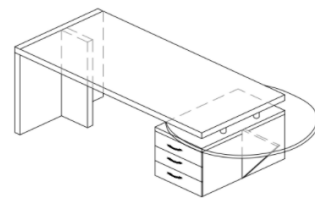

ESCRITORIO ELISEUM CON DISCO

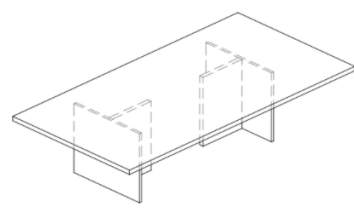

MESA DE REUNIÓN  
RECTANGULAR

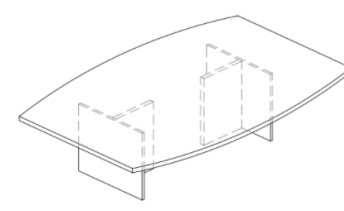

MESA DE REUNIÓN BOTE

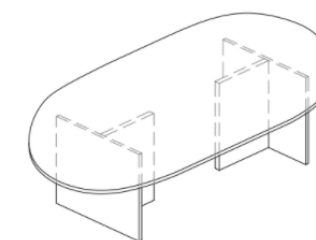

MESA DE REUNIÓN OVAL

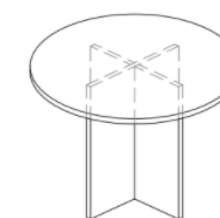

MESA DE REUNIÓN BASE CRUZ

## BIBLIOTECAS

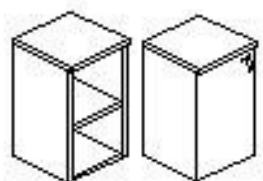

BIBLIOTECA SIMPLE BAJA  
45 X 45 PROF. X 82 ALT.  
ABIERTA O CON PUERTA

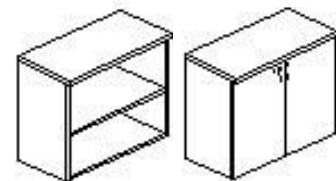

BIBLIOTECA DOBLE BAJA  
90 X 45 PROF. X 82 ALT.  
ABIERTA O CON PUERTAS

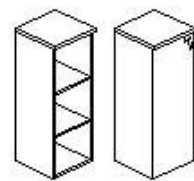

BIBLIOTECA SIMPLE MEDIANA  
45 X 45 PROF. X 135 ALT.  
ABIERTA O CON PUERTA

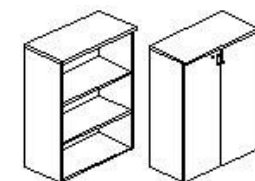

BIBLIOTECA DOBLE MEDIANA  
90 X 45 PROF. X 135 ALT.  
ABIERTA O CON PUERTA

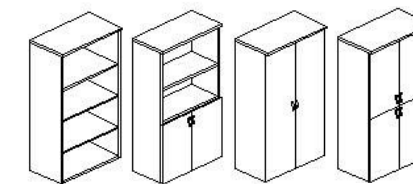

BIBLIOTECA DOBLE ALTA  
90 X 45 PROF. X 180 ALT. ABIERTA, CON  
PUERTAS, ABIERTA CON DOS PUERTAS  
BAJAS, CON CUATRO PUERTAS

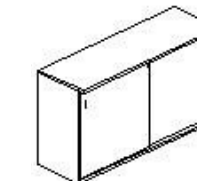

BAJO BIBLIOTECA  
120/135/150/180/200  
X 45 PROF. X 82 ALT.

## FICHEROS

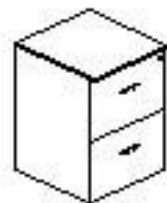

FICHERO SIMPLE BAJO  
47 X 45 PROF. X 82 ALT.

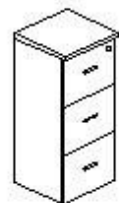

FICHERO SIMPLE MEDIANO  
47 X 45 PROF. X 98 ALT.

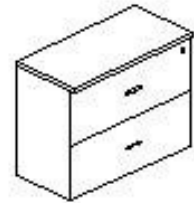

FICHERO DOBLE BAJO  
92 X 45 PROF. X 82 ALT.

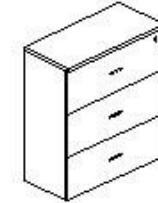

FICHERO DOBLE MEDIANO  
92 X 45 PROF. X 98 ALT.

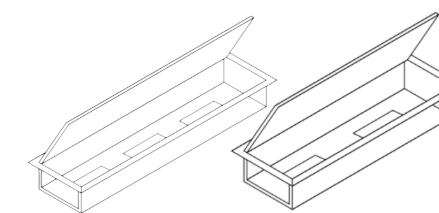

PASACABLE SIMPLE: 27,5 X 11X5  
PASACABLE DOBLE: 42,5 X 11,5

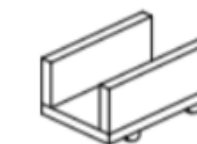

PORTA CPU RODANTE

## CAJONERAS

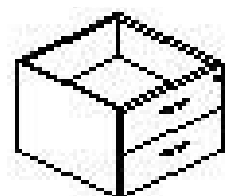

CAJONERA FLOTANTE  
41 X 50 PROF. X 27 ALT.

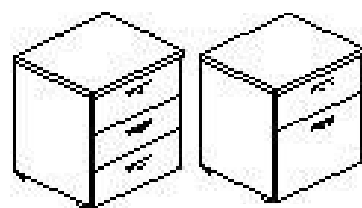

CAJONERA RODANTE  
45 X 45 PROF. X 62 ALT.

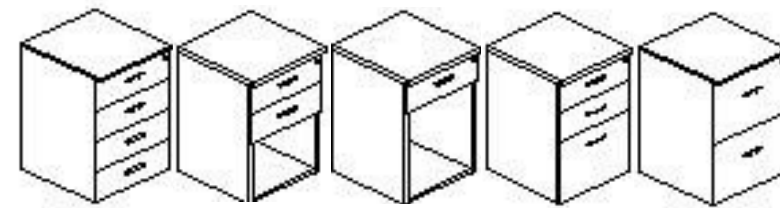

CAJONERA PEDESTAL:  
45 X 45 PROF. X 74 ALT.

### DETALLE DE FABRICACIÓN:

Construido en 36 mm de espesor, con terminaciones rectas, tanto planos de trabajos, tapas y laterales. Opcional en melamina o lustre

Todo el mobiliario está construido bajo tecnología Barilotto, el mejor sistema de anclaje, con tecnología de última generación.

Posibilidad de realizar muebles a medida y sobre diseño.



 SHOWROOM PALERMO, Ciudad de Buenos Aires, Argentina.

Fábrica en Villa del Parque

 Teléfono: 4859.5100

 +54 11 7234-1432

 materynequipamientos

 materynequipamientos

 Materyn Equipamientos

[www.materyn.com](http://www.materyn.com)



**MATERYN**  
EQUIPAMIENTOS